

TOKISTAR Lightstrings



TOKISTAR LIGHTING



Lightstrings

Tokistar® Lightstrings are a system of sockets wired in parallel and permanently attached to flexible, commercial-grade wire. All-weather construction ensures system reliability and installation integrity for years of continuous operation.

Light sources are replaceable energy-efficient TokiLeds with full-range viewing. Our "smart" Kinetic TokiLeds add animation with random cross-fading, blinking and strobing effects. Kinetic LEDs do not require a controller adding to the system's cost efficiency.



Lightstrings attached to tree branches and limbs provide dramatic points of light.



Kinetic cross-fading LEDs behind blue translucent panels create a striking display.

Contents

[Introduction](#) | 2 - 3

[How to Specify / Specifications](#) | 4

[Light Sources / Sizes and Lengths](#) | 5

[Accessories / Dimmer Card](#) | 6

[LED Drivers / Dimming](#) | 7



Cover: Lightstrings are wrapped around each palm tree in this coastal setting.

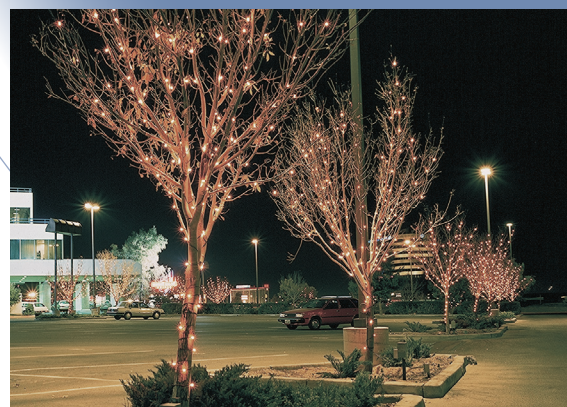

An impressive array of Lightstrings brightens this public parking area.



LEDs are the perfect choice in high-vibration applications, and create a vibrant display on these colorful floats.



Lightstrings incorporated into ceiling tiles with our panel fasteners create a distinctive canopy of blue TokiLeds.

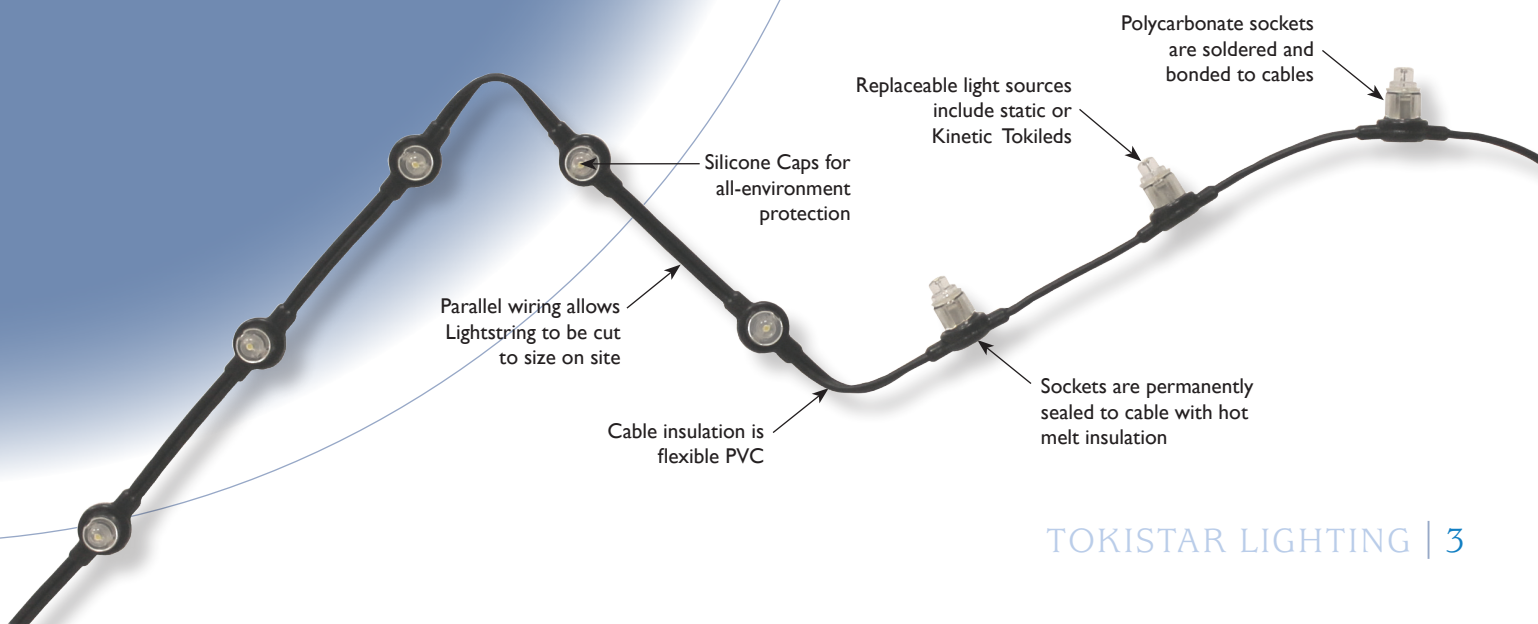



Lightstrings

Tokistar Lightstrings are available with a wide range of LEDs and socket spacings, designed to create brilliant, safe and reliable lighting effects for a diverse range of applications.

How to Specify

Select the appropriate cable color, socket spacing and LED for the application. For outdoor applications, include the ordering code for silicone caps.



Lightstrings are cut on site to precise lengths to follow the contour of each branch.

FLBK - 60 - WW - WP

Lightstring Color		Socket Spacing		TokiLeds			Optional Cap	
Code	Color	Code	Inches (mm)	Code	Color	Watts/Volts	Code	Description
FLBK	Black	60	2.4" (60 mm)	LW	2000K White	0.10 W / 8VDC	WP	Silicone Cap
FLWG	Warm Grey*	110	4.25" (110 mm)	WW	2400K White	0.10 W / 8VDC		
		160	6.25" (160 mm)	IW	3000K White	0.10 W / 8VDC		
	Warm Grey available in 6.25", 8.25" and 12.25"	210	8.25" (210 mm)	WH	6500K White	0.10 W / 8VDC		
		310	12.25" (310 mm)	LW-HB	2000K White	0.20 W / 8VDC		
		410	16.25" (410 mm)	WW-HB	2400K White	0.20 W / 8VDC		
				IW-HB	3000K White	0.20 W / 8VDC		
				WH-HB	6500K White	0.20 W / 8VDC		
				LW-UB	2000K White	0.40 W / 8VDC		
				WW-UB	2400K White	0.40 W / 8VDC		
				IW-UB	3000K White	0.40 W / 8VDC		
				WH-UB	6500K White	0.40 W / 8VDC		
				KLED-WW-SF	2400K White	0.20 W / 8VDC		
				KLED-WW-CF	2400K White	0.20 W / 8VDC		
				KLED-IW-FF	3000K White	0.20 W / 8VDC		
				KLED-IW-SF	3000K White	0.20 W / 8VDC		
				KLED-IW-CF	3000K White	0.20 W / 8VDC		
				KLED-WH-ST	6500K White	0.27 W / 8VDC		
				AM	Amber	0.10 W / 8VDC		
				BL	Blue	0.10 W / 8VDC		
				GR	Green	0.10 W / 8VDC		
				MG	Magenta	0.10 W / 8VDC		
				PL	Purple	0.10 W / 8VDC		
				RD	Red	0.10 W / 8VDC		

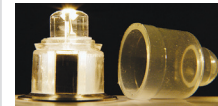
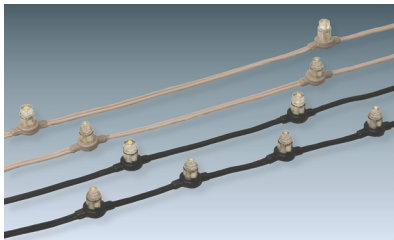

Silicone Caps provide protection in all environments.

Specifications

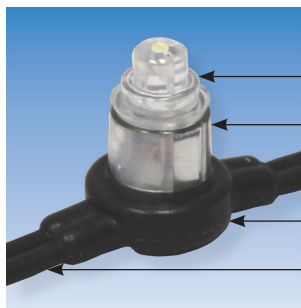

Light Sources include static and Kinetic TokiLeds

Polycarbonate Sockets with flammability rating UL 94V-0

Flexible Conductors are plated #18 AWG

Sockets are soldered and permanently sealed to cable with hot melt insulation

Insulation is flexible PVC with flammability rating UL 94 HB



Intertek

Wet-Location
Listed



IP65
Rated



TokiLeds®

TokiLeds unique phosphor-colored lens reflects light in all directions resulting in full-range viewing. Different LEDs may be combined on the same fixture, including a mix of static and Kinetic TokiLeds.

White TokiLeds do an outstanding job of emulating true incandescent light. Our selection includes a variety of color temperatures and brightness levels.

TokiLeds			
Part Number	LED Color	Watts/Volts	Amps
TLED-LW	2000K White	0.1 W / 8VDC	12.5 mA
TLED-WW	2400K White	0.1 W / 8VDC	12.5 mA
TLED-IW	3000K White	0.1 W / 8VDC	12.5 mA
TLED-WH	6500K White	0.1 W / 8VDC	12.5 mA
TLED-LW-HB	2000K White	0.2 W / 8VDC	25.0 mA
TLED-WW-HB	2400K White	0.2 W / 8VDC	25.0 mA
TLED-IW-HB	3000K White	0.2 W / 8VDC	25.0 mA
TLED-WH-HB	6500K White	0.2 W / 8VDC	25.0 mA
TLED-LW-UB	2000K White	0.4 W / 8VDC	50.0 mA
TLED-WW-UB	2400K White	0.4 W / 8VDC	50.0 mA
TLED-IW-UB	3000K White	0.4 W / 8VDC	50.0 mA
TLED-WH-UB	6500K White	0.4 W / 8VDC	50.0 mA
TLED-AM	Amber	0.1 W / 8VDC	12.5 mA
TLED-BL	Blue	0.1 W / 8VDC	12.5 mA
TLED-GR	Green	0.1 W / 8VDC	12.5 mA
TLED-MG	Magenta	0.1 W / 8VDC	12.5 mA
TLED-PL	Purple	0.1 W / 8VDC	12.5 mA
TLED-RD	Red	0.1 W / 8VDC	12.5 mA

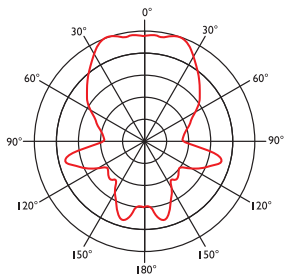

0.1 & 0.2 Watt TokiLeds

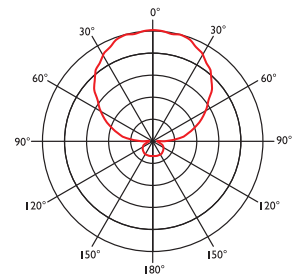

0.27 & 0.4 Watt TokiLeds

Kinetic TokiLeds®

Kinetic TokiLeds are smart LEDs with a microchip to create flashing, cross-fading or strobing effects. LEDs operate independently for a totally random effect.



Flashing
For twinkling effects, the cycle is 0.5 Hz. Faster scintillating effects have a cycle of 4 Hz.



Strobing
Strobing LEDs create distinct and momentary bright-white flashes of light.



Cross-Fading
Cross-Fading LEDs smoothly ramp up to full brightness, then gradually fade to off.

Sizes and Lengths

To minimize voltage drop and keep conductors safely within their rating, do not exceed the maximum lengths shown for each independent fixture.

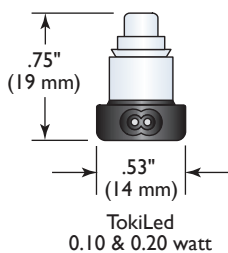

Spacing	Maximum Run Lengths			
	0.1 Watt LED	0.2 Watt LED	0.27 Watt LED	0.4 Watt LED
2.40" (60 mm)	63' (19 M)	40' (12 M)	30' (9 M)	20' (6 M)
4.25" (110 mm)	84' (26 M)	63' (19 M)	48' (14 M)	36' (11 M)
6.25" (160 mm)	100' (30 M)	75' (23 M)	50' (15 M)	50' (15 M)
8.25" (210 mm)	116' (36 M)	87' (26 M)	65' (20 M)	56' (17 M)
12.25" (310 mm)	142' (43 M)	106' (32 M)	80' (24 M)	70' (21 M)
16.25" (410 mm)	164' (50 M)	122' (37 M)	90' (28 M)	82' (25 M)

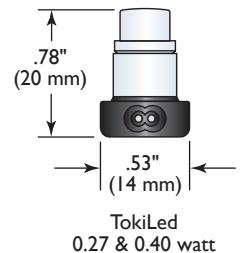



Accessories

Lightstrings are used to create eye-catching displays in trees, and also may be integrated into signs, panels and channel letters. Any combination of LEDs may be used on the same fixture. We offer accessories designed specifically for our product.

SH-02 Panel Mounting

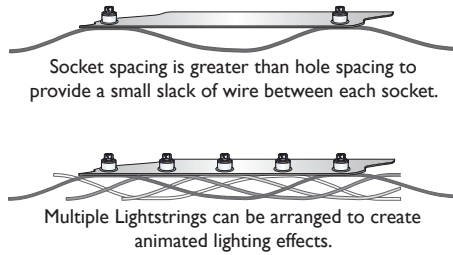

Socket spacing is greater than hole spacing to provide a small slack of wire between each socket.

Multiple Lightstrings can be arranged to create animated lighting effects.



Lightstrings animate channel letters and other features on the exterior of this casino.

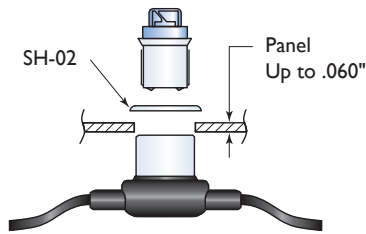

Part#: SH-02

The SH-02 is a stainless steel fastener used to securely attach Lightstring sockets to panels through a 3/8"Ø hole.

For applications requiring independent points of light, our FL-200 & FL-300 sockets are provided with a 12" lead wire.

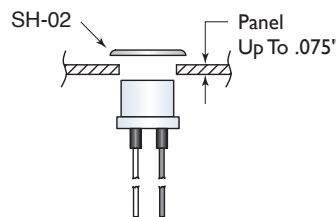

Part#: FL-200

This back-mount socket is for use with the SH-02 fastener. Hole Size: 3/8"Ø

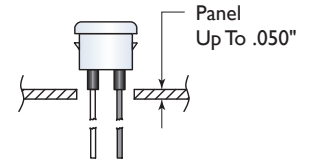

Part#: FL-300

For front-mount applications, this socket remains close to flush with the surface. Hole Size: 3/8"Ø

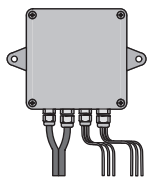

Part#: HC-10

This gasketed junction box accepts #12 AWG Landscape Cable, which may be spliced to 6 independent Lightstring fixtures (3 per output).



Part#: EC-FL

Lightstrings may be cut to size on site. Vinyl end caps insulate the end of the wire.

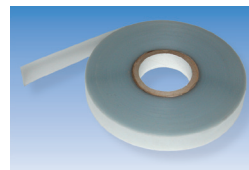

Part#: NSY-TP-200

Clear elastic nursery tape may be used to secure Lightstrings to branches without prohibiting plant growth

Opt Bouquet

Opt Bouquet are edge-lit translucent acrylic petals which snap onto Tokistar Lightstring sockets. The petals create a more pronounced light source, making it possible to provide greater impact from more distant spacing. They can be installed in the field or attached at our factory. They work with any color and variety of TokiLeds.

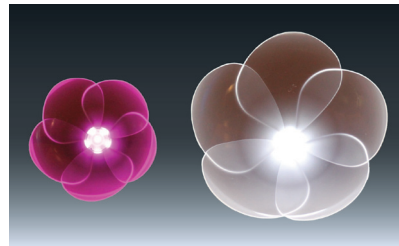

OPT-115-LG

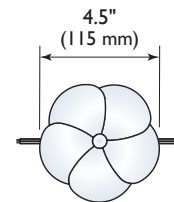

OPT-75-SM

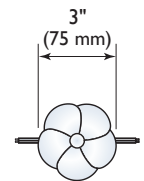

0/1-10VDC Dim Card

Part #: LDR-DIM

This component is connected to the secondary output of our LED drivers and works from industry-standard 0/1-10VDC dimmers. The output to our fixtures is Pulse Width Modulation (PWM) for flicker-free operation. Two dimmer cards are required when using our dual output LDR8-80 driver.



Dim Cards are small enough to fit within the wiring compartment of our LDR8-40 LED driver or may be installed externally.

Technical Specifications:

- Control Voltage: 0/1-10VDC
- Input Voltage: 8VDC
- Max. Load: 40 Watts/5 Amps
- Dimming Ratio: 1:10,000
- Weatherability: Damp Location/IP65
- Size: 0.6" x 2.2" x 5.3" Weight: 55g
- Operating Temp: -20°C to 60°C
- Case Material: White Polycarbonate
- Approvals: UL Listed/CE Certified
- Complies with EN55015/FCC Part 15

LED Drivers

Tokistar's LDR8-40 is a 40 Watt Class 2 LED driver used to convert an AC input into an 8VDC output. It may be operated from a wide range of input voltages and is wet-location listed.



LDR8-40

Specifications

Input Range: 100~240VAC
 Frequency Range: 50/60 Hz
 Output: 8VDC (Adjustable +10% / -25%)
 Max. Output Current: 5.0A
 Max. Output Power: 40W
 Protection: Overload, Overcurrent, Short Circuit
 Operating Temperature: -30°C to +60°C

Mechanical Specifications

Dimensions: 3" x 9.75" x 2"
 Weight: 1.94 lbs
 Enclosure Rating: Nema 3/IP65
 Mounting: Flange Mount
 Connection: Knockouts for 1/2" Conduit

LED Capacity

0.10 Watt LEDs: 400 each
 0.20 Watt LEDs: 200 each
 0.27 Watt LEDs: 148 each
 0.40 Watt LEDs: 100 each

Tokistar's LDR8-80 is a dual output Class 2 LED driver with two independent 40 Watt outputs. It may be operated from a wide range of input voltages and is wet-location listed.



LDR8-80

Specifications

Input Range: 100~240VAC
 Frequency Range: 50/60 Hz
 Output: 8VDC (Adjustable +5% / -30%)
 Max. Output Current: 10.0A (2 @ 5.0A)
 Max. Output Power: 80W (2 @ 40W)
 Protection: Overload, Overcurrent, Short Circuit
 Operating Temperature: -30°C to +60°C

Mechanical Specifications

Dimensions: 3.6" x 11" x 2.25"
 Weight: 4 lbs
 Enclosure Rating: Nema 3/IP65
 Mounting: Flange Mount
 Connection: Knockouts for 1/2" Conduit

LED Capacity

0.10 Watt LEDs: 800 each
 0.20 Watt LEDs: 400 each
 0.27 Watt LEDs: 296 each
 0.40 Watt LEDs: 200 each

LED Dimmers

LC Dimming System

This proprietary Dimming System provides full-range dimming of Tokileds. The system components connect with CAT5 cable. Up to 25 dimmer packs may be connected in series if the total length of all CAT5 cable does not exceed 165 feet from the wall dimmer to the last dimmer pack. CAT5 cables are included with units.

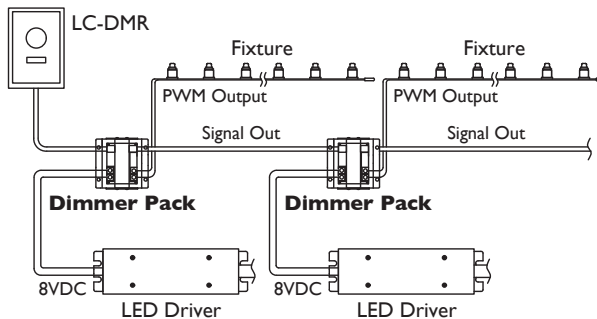

Part #: LC-DMR

The remote wall dimmer has a rotary dial and on/off switch. Power to the wall dimmer is provided from the LED driver powering the first dimmer pack.



Part #: LC-1CH-DP

Each dimmer pack receives an 8VDC input from an LED driver and sends a PWM output to the fixture. Logic input and output is communicated through CAT5 cable. Dimensions: 1-1/2" x 3-1/2" x 4-1/16"

LC-1CH-Multi System

Tokistar's LC-1CH-MULTI Dimmer Pack is compatible with industry-standard dimmers working on DMX or 0/1-10VDC protocol. In the manual mode, a preset light level can be set without the use of an external dimmer. In the DMX mode, the dimmer pack is addressable.

Part #: LC-1CH-MULTI

Max. Load: 40 Watts @ 8VDC
 Environmental Rating:
 Dry Location/IP20
 Dimensions: 3/4" x 1-3/4" x 3-1/2"
 Weight: 50g / 0.11 lbs
 Listing: ETL Listed/CE Certified
 Operating Temperature: 0~+50°C

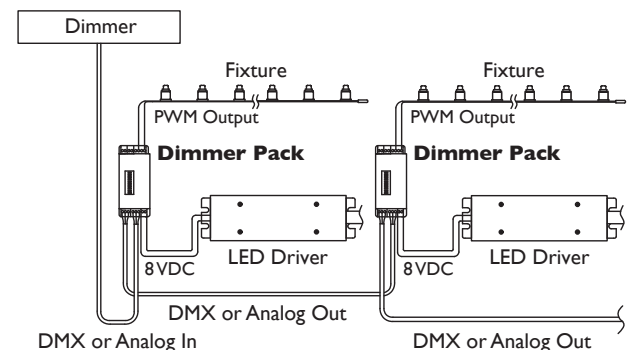

Dual output LED Drivers require a dimmer pack for each output.



TOKISTAR® LIGHTING INC.

1015 E. Discovery Lane • Anaheim, CA 92801
 Tel: 714.772.7005 • Fax: 714.772.7014 • Toll free in USA: 877.340.7633
 Email: info@tokistar.com • Website: www.tokistar.com